

XO INSTALLATION INSTRUCTIONS

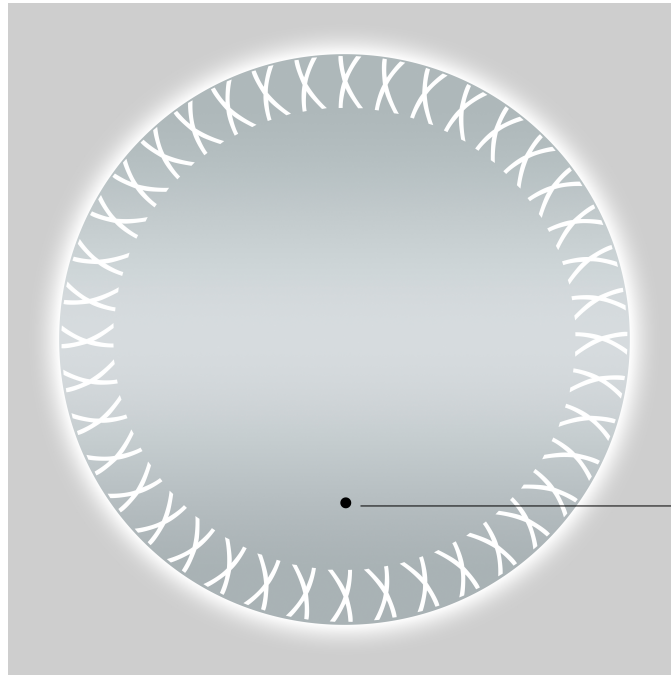

IR switch

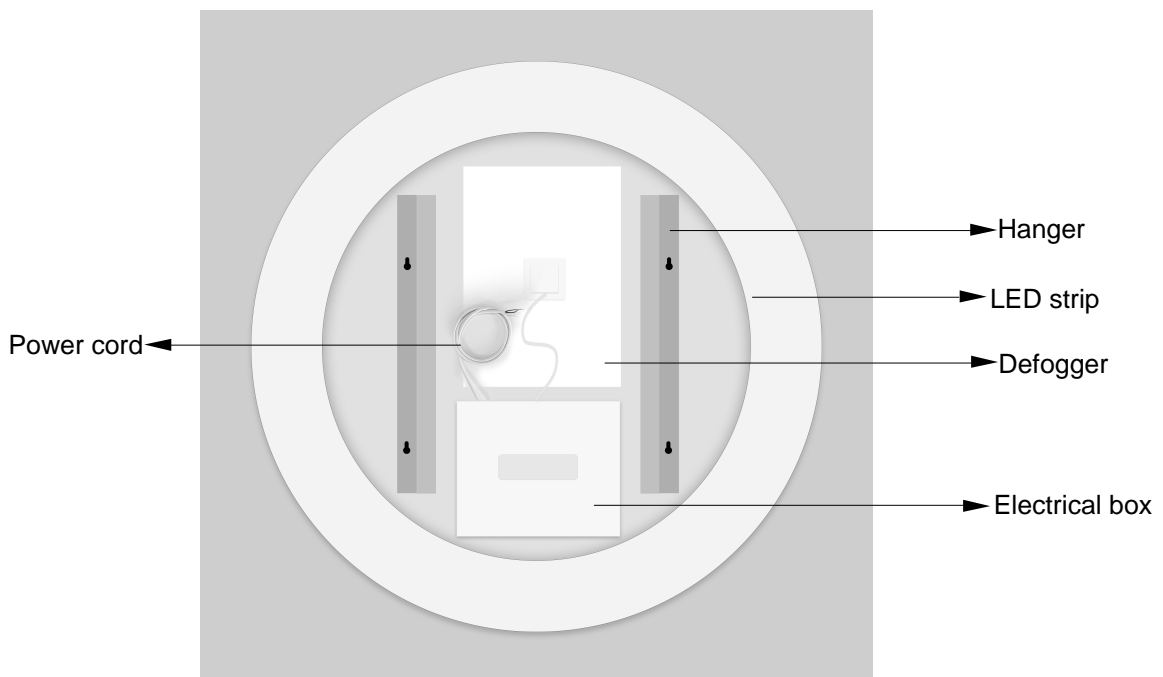

Power cord

Hanger

LED strip

Defogger

Electrical box

XO INSTALLATION INSTRUCTIONS

Warnings and precautions for use regarding the electrical connections.

Our products are intended exclusively for indoor use. The electrical connection and any subsequent electrical adjustments must be carried out solely by a qualified electrician, who will adhere to all applicable electrical regulations and instructions. In the event that the external flexible cable or cord of this appliance becomes damaged, it must be replaced solely by the manufacturer or their authorized agent to prevent any potential hazards.

Mirror/Sensor Operation:

ON/OFF: To activate or deactivate the mirror, wave your hand in front of the sensor located on the mirror's face.

DIMMING: While the mirror is activated, position your hand in front of the infrared sensor to adjust the brightness level, ranging from 5% to 100%, and vice versa. Once you've achieved your desired brightness, remove your hand, and the sensor will retain this setting for subsequent activations. As long as your hand remains in front of the sensor, the mirror will continue adjusting brightness. Removing your hand during this process will halt the adjustment and save the current brightness level. Placing your hand back in front of the sensor and holding it there will initiate brightness adjustment in the opposite direction. For example, if you initially dimmed the light by holding your hand in front of the sensor, removing your hand would preserve that output level. Replacing your hand and maintaining its position would then increase the brightness.

COLOR TUNING: When the mirror's lighting is off, maintain your hand in front of the sensor. After a brief delay, the mirror will automatically activate and slowly tune the color temperature between 3000K and 6000K, and vice versa. Once the desired color temperature is reached, remove your hand, and the sensor will store this setting for subsequent activations, ensuring consistent color temperature.



Appliance not suitable for being covered with thermal insulation material.



Appliance for indoor use only.

XO INSTALLATION INSTRUCTIONS

TOOLS REQUIRED



1. Gather a pencil, level, measuring tape, stud finder, and painter's tape. Retrieve the fixing bar from the packaging.

Contains:

1 x Mirror, screws, wall plugs, paper template

2

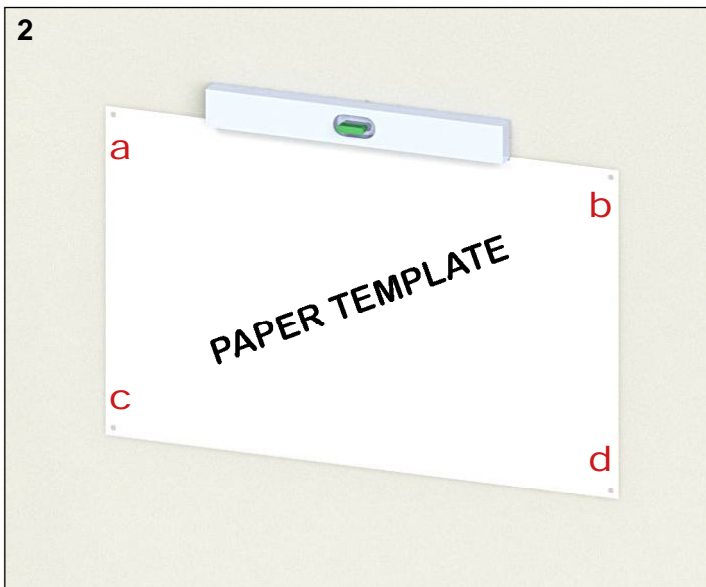

2. In order to facilitate installation we have included a paper template to drill the holes in the wall.

3. Unfold the paper template and apply on the mirror back to ensure that the holes match up.

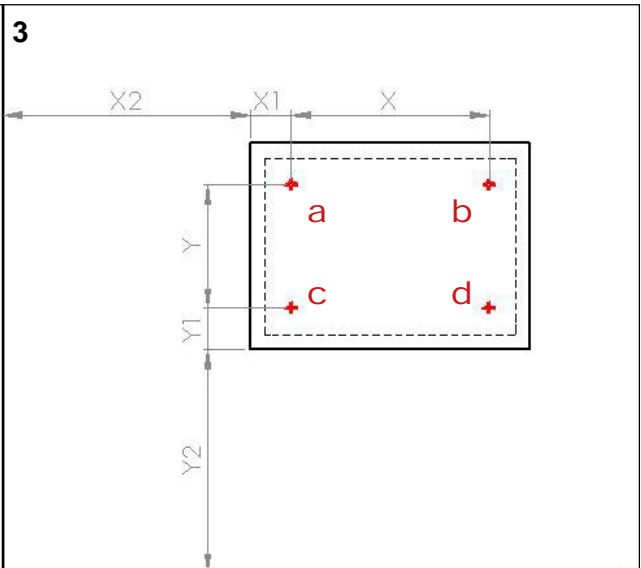

XO INSTALLATION INSTRUCTIONS

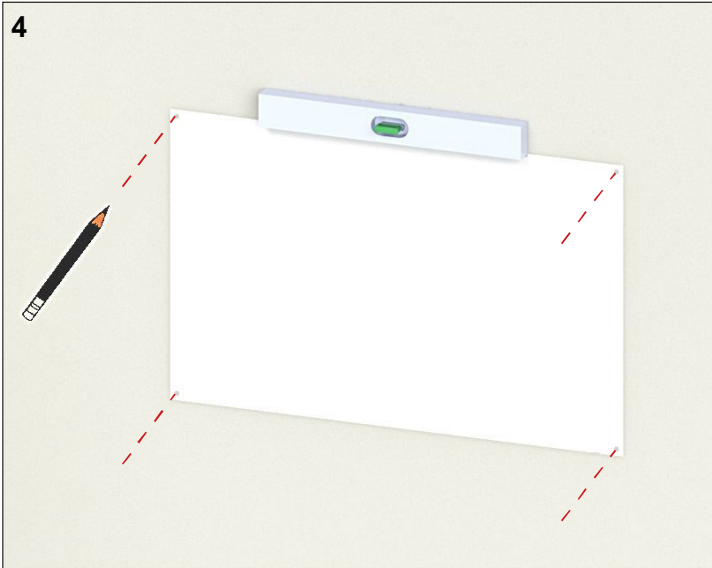

4. Tape the paper template to the wall taking into consideration the position of the mounting holes and the mirror edge. With a level, position the template so that it is perfectly level.

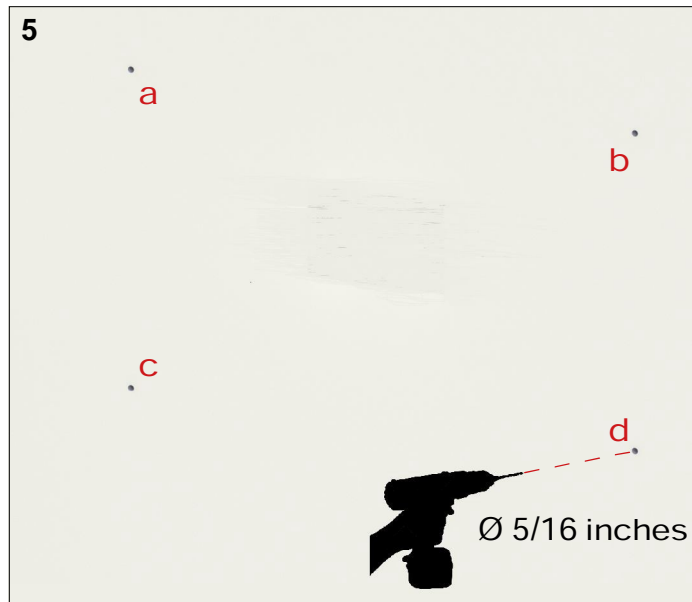

5. Ensure that there are no water pipes or electrical wiring behind the fixing points.

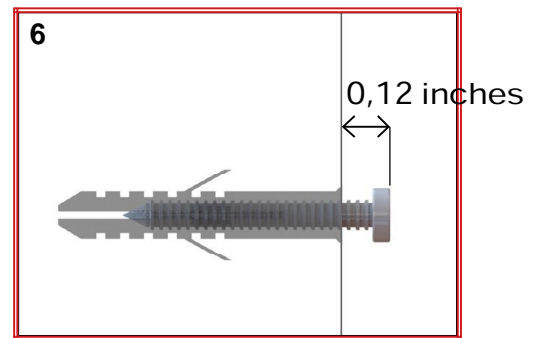

a-b-c-d

6. Drill and insert the screw anchors suited to the type of wall to which the mirror will be fixed (only screws in the case of wood studs).

XO INSTALLATION INSTRUCTIONS

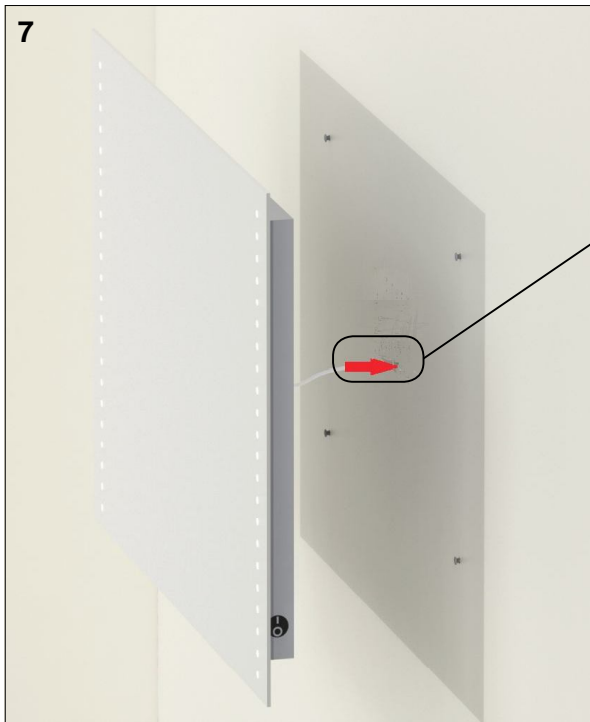

WIRING DIAGRAM

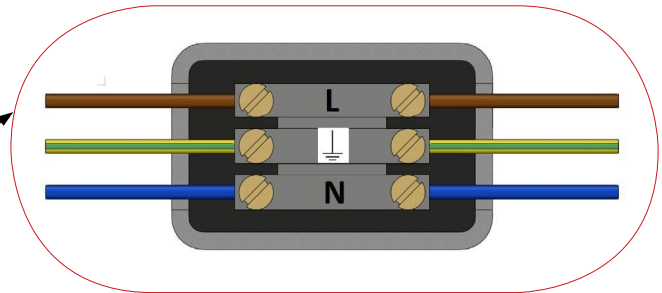

7. Turn off the power.

Connect the mirror wiring in an IP44 approved connect box (not included) which can be inserted into the wall anywhere behind the mirror.

Before hanging the mirror, consult an electrician to make the necessary electrical connections. Ensure the connections are made in an approved junction box suitable for the installation environment. All three wires (line, neutral, and ground) must be connected to the power source.

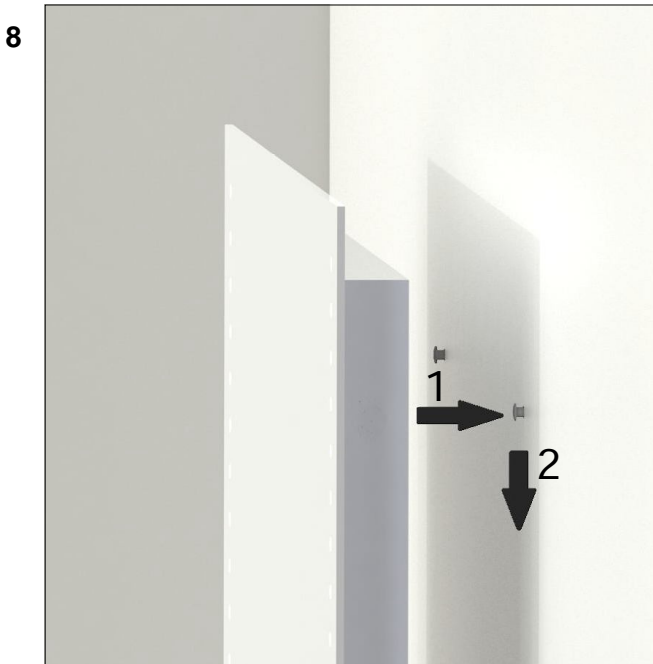

8. Hang the mirror.

NOTES:

- Avoid touching the sensor directly.
- Position your hand approximately 4" - 6" away from the sensor.
- When waving, avoid excessive speed.
- Once you've adjusted your mirror to the desired color temperature and brightness level, simply power off the mirror, and all settings will be saved automatically. When you power the mirror back on, it will restore to the settings you previously configured. Our mirrors feature a memory function, ensuring they retain the last settings used upon powering back on.
- If your mirror is connected to a 120V switch, leave the mirror powered on and use the switch to turn it off (disconnect from power). Upon switching it back on, the mirror will revert to the same light output and color temperature settings as before.
- Please note that this mirror is not compatible with dimmer switches or low voltage controls. Color tuning and dimming adjustments must be made directly on the mirror itself.
- The defogging function is automatically activated when the mirror is ON. The defogger will regulate itself if the mirror is left ON for an extended period of time.
- The defogger will heat the mirror so as to prevent fog from obstructing your view on the mirror. Your mirror may feel warm to the touch.

Product Care:

1. Do not use abrasives or solvents when cleaning your mirror. Low PH products and a polishing or soft cloth are recommended.
2. Do not spray the mirror directly with cleaning solution. Spray the cloth and then wipe the mirror with the moist cloth.
3. If the mirror has been turned on for an extended period of time, turn it off and let it cool - if equipped with a defogger - before cleaning.

Product Life:

At the end of its useful life, entrust the unit to the local waste disposal company.